



3M Full Facepiece Respirator 6000 Series

*User Instructions for 3M™ Small 6700, Small 07138,
Medium 6800, Medium 07139, Large 6900, Large 07140
Full Facepieces*

Important: Keep these *User Instructions* for reference.

*07138, 07139, 07140 are catalog numbers only. NIOSH approved 3M™ Small 6700, Medium 6800, Large 6900 Full Facepiece.

GENERAL SAFETY INFORMATION

Intended Use

The 3M™ Full Facepiece Respirators 6000 Series are NIOSH approved and designed to help provide respiratory protection against certain airborne contaminants when used in accordance with all use instructions and limitations and applicable safety and health regulations.

The 3M Full Facepiece 6000 Series meets the requirements of the ANSI Z87.1-2003 standard, high impact level, for face and eye protection. These products help provide limited eye and face protection against flying particles.

This product contains no components made from natural rubber latex.



⚠ WARNING

This respirator helps protect against certain airborne contaminants. **Misuse may result in sickness or death.** For proper use, see your supervisor, or *User Instructions* or call 3M in U.S.A. at 1-800-243-4630. In Canada, call Technical Service at 1-800-267-4414.

These *User Instructions* provide information about facepiece use only. Important information is provided in the *User Instructions* with each of the air filtration/supplied air systems that are NIOSH certified to be used with the Full Facepiece Respirator 6000 Series. Failure to follow *User Instructions* for the air filtration/supplied air systems being used **may result in sickness or death.**

Do not clean respirator with solvents. Cleaning with solvents may degrade some respirator components and reduce respirator effectiveness. Inspect all respirator components before each use to ensure proper operating conditions. **Failure to do so may result in sickness or death.**

When in supplied air mode, your employer must provide breathing air that meets at least the requirements of the specification for Grade D breathing air, as described in the Compressed Gas Association Commodity Specification G-7.1-1997 in the United States. In Canada, breathing air systems must be supplied with air, which meets at least the requirements of CSA Standard Z180.1. Failure to do so **may result in sickness or death.**

USE INSTRUCTIONS AND LIMITATIONS

Important

Before use, the wearer must read and understand these *User Instructions*. Keep these *User Instructions* for reference.

Use For

Respiratory protection from certain airborne contaminants according to NIOSH approvals, OSHA limitations, in Canada CSA standard Z94.4 requirements, other applicable regulations and 3M instructions.

Do Not Use For

Concentrations of contaminants which are immediately dangerous to life or health, are unknown or when concentrations exceed 10 times the permissible exposure limit (PEL) in air-purifying mode when qualitatively fit tested, 50 times the PEL in air purifying mode when quantitatively fit tested, 1000 times the PEL when used in supplied air mode, or according to specific OSHA standards or applicable government regulations, whichever is lower.

Use Instructions

1. Failure to follow all instructions and limitations on the use of this respirator and/or failure to wear this respirator during all times of exposure can reduce respirator effectiveness and **may result in sickness or death.**
2. Before occupational use of this respirator a written respiratory protection program must be implemented meeting all the requirements of OSHA 29 CFR 1910.134 such as medical evaluation, training and fit testing and applicable OSHA substance specific standards. In Canada, follow the recommendations of CSA Z94.4 and/or requirements of the applicable jurisdiction, as appropriate. When used in supplied air mode, your employer must supply breathing air that meets at least the requirements of Grade D breathing air in Compressed Gas Association Commodity Specifications G-7.1-1997. In Canada, breathing air systems must be supplied with air which meets at least the requirements of CSA Standard Z180.1.
3. The airborne contaminants, which can be dangerous to your health, include those that are so small you may not be able to see or smell them.
4. Leave contaminated area immediately and contact supervisor if you smell or taste contaminants or if dizziness, irritation, or other distress occurs.
5. Store respirator away from contaminated areas when not in use.
6. Dispose of used product in accordance with applicable regulations.

Use Limitations

1. This respirator does not supply oxygen when used in air-purifying mode. Do not use in atmospheres containing less than 19.5% oxygen.
2. Do not use when concentrations of contaminants are immediately dangerous to life or health, are unknown or when concentrations exceed 10 times the permissible exposure limit (PEL) in air-purifying mode when qualitatively fit tested, 50 times the PEL in air-purifying mode when quantitatively fit tested, 1000 times PEL in supplied air mode, or according to specific OSHA standards or applicable government regulations, whichever is lower.
3. Do not alter, abuse or misuse this respirator.
4. Do not use with beards or other facial hair or other conditions that prevent a good seal between the face and the faceseal of the respirator.

Time Use Limitations

1. If respirator becomes damaged, leave the contaminated area immediately and repair or replace the respirator.
2. Replace filters in accordance with the filter Time Use Limitations. (See filter User Instructions.)
3. Replace cartridges in accordance with an established change schedule or earlier if smell, taste or irritation from contaminants is detected.

NIOSH Cautions and Limitations

The following restrictions may apply. See NIOSH Approval Label.

- A- Not for use in atmospheres containing less than 19.5 percent oxygen.
- B- Not for use in atmospheres immediately dangerous to life or health.
- C- Do not exceed maximum use concentrations established by regulatory standards.
- D- Air-line respirators can be used only when the respirators are supplied with respirable air meeting the requirements of CGA G-7.1 Grade D or higher quality.
- E- Use only the pressure ranges and hose lengths specified in the *User's Instructions*.
- F- Do not use powered air-purifying respirators if airflow is less than four cfm (115 lpm) for tight fitting facepieces or six cfm (170 lpm) for hoods and/or helmets.
- G- If airflow is cut off, switch to filter and/or cartridge or canister and immediately exit to clean air.
- H- Follow established cartridge and canister change schedules or observe ESLI to ensure that cartridges and canisters are replaced before breakthrough occurs.
- I- Contains electrical parts which have not been evaluated as an ignition source in flammable or explosive atmospheres by MSHA/NIOSH.
- J- Failure to properly use and maintain this product could result in injury or death.
- L- Follow the manufacturer's *User's Instructions* for changing cartridges, canister and/or filters.
- M- All approved respirators shall be selected, fitted, used, and maintained in accordance with MSHA, OSHA, and other applicable regulations.
- N- Never substitute, modify, add, or omit parts. Use only exact replacement parts in the configuration as specified by the manufacturer.
- O- Refer to *User's Instructions*, and/or maintenance manuals for information on use and maintenance of these respirators.
- P- NIOSH does not evaluate respirators for use as surgical masks.
- S- Special or critical *User's Instructions* and/or specific use limitations apply. Refer to *User's Instructions* before donning.

S-Special or Critical *User's Instructions*

3M™ Mercury Vapor Cartridges (6009 and 60929) are equipped with passive 3M™ End of Service Life Indicators (ESLI). The color change indicator must be readily visible when wearing the respirator without manipulation. If you cannot readily see the ESLI, do not use. The mercury vapor cartridges must be discarded when the ESLI changes to the discard color found on the mercury vapor cartridge label; or within 30 days of opening packaging; or when ESLI becomes dirty or damaged; or when odors of vapors or gases become noticeable, whichever occurs first. Mercury vapor has no odor.

To assemble 3M™ Dual Airline Combination Breathing Tubes with 3M™ Cartridges/Filters, the facepiece inhalation valves must be removed.

If the facepiece is to be used in air-purifying mode (without using the 3M™ breathing tubes SA-1600 or SA-2600), the inhalation valves must be replaced in the facepiece before use.

Use of the 3M™ Nose Cup Assembly 6894 with the 3M™ 6000 Series Full Facepieces must be in accordance with the NIOSH approval for the system being used.

–Nose cup is not to be used with the Powerflow™ Face-Mounted PAPR

–Nose cup use is optional with 3M™ GVP and Breathe Easy™ Belt-Mounted PAPR systems.

–Nose cup must be used for all other 6000 facepiece applications.

Refer to the specific 3M product *User Instructions* for more information.

Cartridge and Filter Selection and Approvals

Before using any of these products, the user must read the specific use for, use limitations and warning information in the *User Instructions* and product documentation or call OH&ESD Technical Service at 1-800-243-4630. In Canada, call Technical Service at 1-800-267-4414. Do not exceed maximum use concentrations established by local regulatory agencies. Cartridges/filters are approved as assemblies for use with 3M™ Facepiece 6000 Series. For NIOSH approval, refer to approval label.

LIST OF PRODUCTS

3M™ Full Facepiece 6000 Series Replacement Parts and Accessories Full Facepiece with Standard Center 3M™ Adapter 6864

Number	****AAD	Description
6700	07138	Small
6800	07139	Medium
6900	07140	Large

****AAD part numbers are catalog numbers only. NIOSH approved as OH&ESD part numbers

Number	****AAD	Description	
1	6864	Center Adapter Assembly (Standard)	
1A		Center Adapter Cover*	
1B	7583	Exhalation Valve	
1C		Center Adapter Base*	
1D	6896	Center Adapter Gasket	
2	6884	DIN Port Adapter Assembly	
2A	6882	DIN Cover	
2B	3876	Breathing Tube Gasket	
2C	6889	Exhalation Valve	
2D	6883	DIN Port Base	
2E	6896	Center Adapter Gasket	
2F	6881	DIN Air Director	
2G	7980	Full Face Plug	
4	6880	Bayonet Cap	
5	6895	07145	Inhalation Gasket
6	6893	07144	Inhalation Valve
7	6898	37006	Lens Assembly
8	6894	37004	Nose Cup Assembly
9	6899	37007	Frame Assembly w/ Screws
10	6897	37005	Head Harness Assembly

*Not available separately

****AAD part numbers are catalog numbers only. NIOSH approved as OH&ESD part numbers

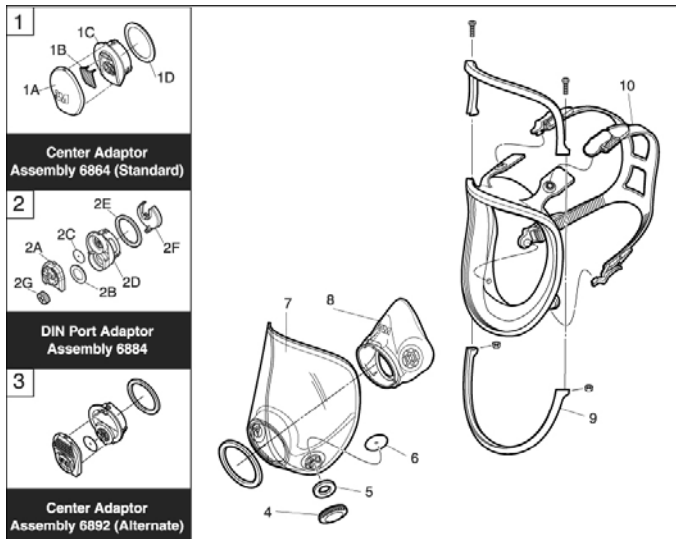

3M™ Accessories and Parts

Number	****AAD	Description
504	07065	Respirator Cleaning Wipes
601		Quantitative Fit Test Adapter
6878	07141	Spectacle Kit
6885	07142	Lens Cover
6886		Tinted Lens Cover
7883		Neck Strap Assembly

****AAD part numbers are catalog numbers only. NIOSH approved as OH&ESD part numbers

CAUTION

Failure to properly dispose of spent cartridges, filters, or respirators contaminated by hazardous materials can result in personal exposures as well as environmental harm. Handling, transportation and disposal of spent cartridges, filters, or respirators must comply with all applicable federal, state, and local laws and regulations.

3M™ 6000 Series Cartridges

Number	****AAD	Description	NIOSH Approval for respiratory protection against the following contaminants up to ten times the permissible exposure limit (PEL) when qualitatively fit tested, up to fifty times the PEL when quantitatively fit tested, and up to 1000 times the PEL in powered air-purifying or supplied air mode.
6001	07046	Organic Vapor	Certain organic vapors
6002		Acid Gas	Chlorine, hydrogen chloride, and sulfur dioxide or chlorine dioxide or hydrogen sulfide.
6003	07047	Organic Vapor/Acid Gas	Certain organic vapors, chlorine, hydrogen chloride, and sulfur dioxide or hydrogen sulfide or hydrogen fluoride
6004		Ammonia/Methylamine	Ammonia and methylamine
6005		Formaldehyde/Organic vapor	Formaldehyde and certain organic vapors
6006		Multi-Gas/Vapor	Certain organic vapors, chlorine, hydrogen chloride, chlorine dioxide, sulfur dioxide, hydrogen sulfide, ammonia/methylamine, formaldehyde or hydrogen fluoride
6009		Mercury Vapor/Chlorine Gas	Mercury vapor or chlorine gas
60921		Organic Vapor/P100	Certain organic vapors and particulates
60922		Acid Gas/P100	Chlorine, hydrogen chloride, and sulfur dioxide or chlorine dioxide or hydrogen sulfide and particulates
60923		Organic Vapor/Acid Gas/P100	Certain organic vapors, chlorine, hydrogen chloride, and sulfur dioxide or hydrogen sulfide or hydrogen fluoride and particulates
60924		Ammonia/Methylamine/P100	Ammonia and methylamine and particulates
60925		Formaldehyde/Organic Vapor/P100	Formaldehyde and certain organic vapors and particulates
60926		Multi-Gas/Vapor/P100	Certain organic vapors, chlorine, hydrogen chloride, chlorine dioxide, sulfur dioxide, hydrogen sulfide, ammonia/methylamine, formaldehyde or hydrogen fluoride and particulates
60928		Organic Vapor/Acid Gas/P100	Certain organic vapors, chlorine, hydrogen chloride, and sulfur dioxide or hydrogen sulfide or hydrogen fluoride and particulates. ¹
60929		Mercury Vapor/Chlorine Gas/P100	Mercury vapor or chlorine gas and particulates

****AAD part numbers are catalog numbers only. NIOSH approved as OH&ESD part numbers

¹ 3M recommended for use against methylbromide or radioiodine up to 5 ppm with daily cartridge replacement. **Note: Not NIOSH approved for use against methylbromide or radioiodine.**

Service Life of Chemical Cartridges and Filters

3M™ Chemical Cartridges 6000 Series must be used before the expiration date on cartridge packaging. The useful service life of these cartridges will depend upon activity of wearer (breathing rate), specific type, volatility and concentration of contaminants and environmental conditions such as humidity, pressure, and temperature. Cartridges must be replaced in accordance with an established change schedule, regulations or earlier if smell, taste or irritation from contaminants is detected.

Filters must be replaced if they become damaged, soiled or if increased breathing resistance occurs. N-series filters should not be used in environments containing oils. R-series filters may be limited to 8 hours of continuous or intermittent use if oil aerosols are present. In environments containing only oil aerosols, P-series filters should be replaced after 40 hours of use or 30 days, whichever is first.

3M™ Filters, Adapters, Retainers

Note: Only 3M™ Filters approved under NIOSH 42 CFR 84 are to be used with the 3M™ Full Facepiece 6000 Series.

Number	****AAD	Description
501	07054	Filter Retainer for Filters 5N11 and 5P71
502		Filter Adapter for Filters 2000 Series and 7093/7093C
2071		Particulate Filter, P95
2076HF		Particulate Filter, P95, hydrogen fluoride, with nuisance level acid gas relief ¹
2078		Particulate Filter, P95, 3M recommended ozone protection ² , with nuisance level organic vapor/acid gas relief ¹
2091	07000	Particulate Filter, P100
2096		Particulate Filter, P100, with nuisance level acid gas relief ¹
2097	07184	Particulate Filter, P100, 3M recommended for ozone protection ² , with nuisance level organic vapor/acid gas relief ¹
5N11		Particulate Filter, N95
5P71	07194	Particulate Filter, P95
7093		Particulate Filter, P100
7093C	37173	Particulate Filter, P100, hydrogen fluoride, with nuisance level organic vapor/acid gas relief ¹

****AAD part numbers are catalog numbers only. NIOSH approved as OH&ESD part numbers

¹ 3M recommended for relief against nuisance levels of acid gas or organic vapors. Nuisance level refers to concentrations not exceeding OSHA PEL or applicable exposure limits, whichever is lower. Do not use for respiratory protection against acid gas/organic vapors.

² 3M recommended for ozone protection up to 10 times the OSHA PEL or applicable government occupational exposure limits, whichever is lower. **Note: Not NIOSH approved for use against ozone.**

3M particulate filters must be immediately changed when an increase in breathing resistance is noticed.

ASSEMBLY INSTRUCTIONS

Note: Make certain 3M™ Inhalation Port Gaskets 6895 are in place on the facepiece bayonet connectors before installing filters, cartridges or breathing tubes.

3M™ 6000 Series Cartridge Assembly

1. Align the cartridge notch with the small solid bayonet lug on facepiece and push together.
2. Turn cartridge clockwise to stop (1/4 turn).
3. Repeat with second cartridge. (Fig. 1)

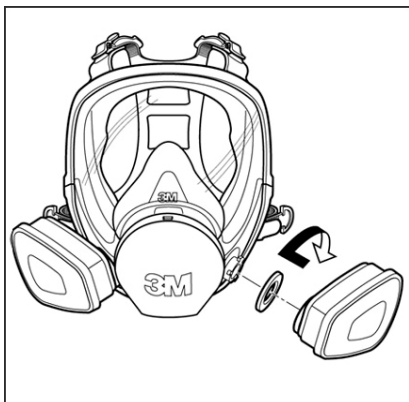

Fig. 1

3M™ Filter 2000 Series and 7093/7093C Assembly

1. Align opening of filter with filter attachment on facepiece.
2. Turn filter clockwise until it is firmly seated and cannot be further turned.
3. Repeat for second filter. (Fig. 2)

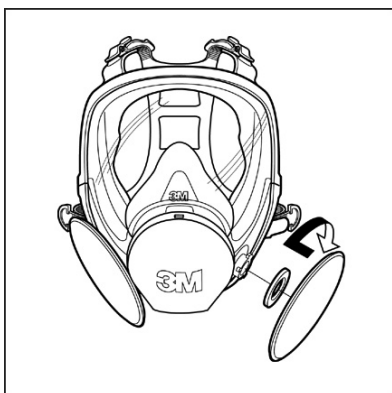

Fig. 2

Filter Assembly (for 3M™ Filters 5N11 and 5P71)

1. Place filter into 3M™ Retainer 501 so printed side of filter faces the cartridge.
2. Press cartridge into filter retainer. It should snap securely into filter retainer. When correctly installed, filter should completely cover face of cartridge. (Fig. 3)
3. To replace filter, remove retainer by lifting on TAB.

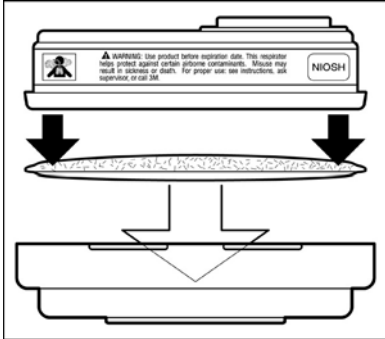

Fig. 3

3M™ Filter Adapter 502 Assembly and Filter Attachment

1. Align adapter over cartridge. Engage front snap by squeezing front of cartridge and adapter together, placing thumbs of both hands over top of adapter and fingers along bottom sides of cartridge. (Fig. 4)
2. Engage back snap by squeezing back side of cartridge and adapter together using the same hand positions. An audible click should be heard as each snap is engaged. (Fig. 5)
3. Place filter onto the filter holder so that filter comes into even contact with gasket. Twist clockwise a quarter turn until it is firmly seated and filter cannot be turned further. Repeat for second filter.

Note: The 3M™ Filter Adapter 502, once installed on a 3M™ Cartridge 6000 Series, is not to be removed or reused. Removal or reuse may result in leakage, overexposure, sickness or death.



Fig. 4

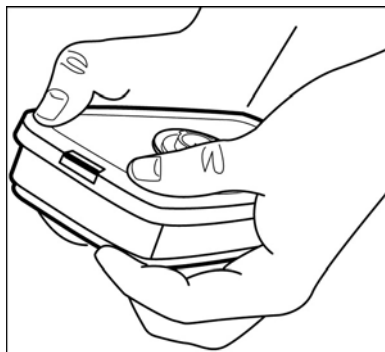

Fig. 5

3M™ Filters 2000 Series and 7093/7093C with 3M™ Filter Adapter 502

Place filter onto the filter holder so that filter comes into even contact with gasket. Twist clockwise one quarter turn until it is firmly seated and filter cannot be turned further. Repeat for second filter.

Note: The 3M™ Filter Adapter 502, once installed on a 3M™ Cartridge 6000 Series, is not to be removed or reused. Removal or reuse may result in leakage, overexposure, sickness or death.

3M™ Supplied Air Systems

WARNING

To meet the U.S. National Institute for Occupational Safety and Health (NIOSH) requirement for minimum (4 CFM/115 lpm) and maximum (15 CFM/424 lpm) air flow, the air control valves approved for use with the 3M 6000 Series Full Facepiece Respirators must be operated within the correct supply pressure ranges and hose lengths. Failure to do so **may result in sickness or death.**

WARNING

Your employer must provide breathing air that meets at least the requirements of the specification for Grade D breathing air, as described in the Compressed Gas Association Commodity Specification G-7.1-1997 in the United States. In Canada, breathing air systems must be supplied with air, which meets at least the requirements of CSA Standard Z180.1. Failure to do so **may result in sickness or death.**

3M™ Dual Airline Respirator Assembly

User must follow Dual Airline Supplied Air Respirator *User Instructions* provided with the 3M™ Dual Airline Supplied Air Respirators.

Assembly of 3M™ Combination Dual Airline Respirator with Cartridges and/or Filters

The 3M™ SA-1600 (front-mounted) and SA-2600 (back-mounted) versions of the 3M dual airline breathing tubes allow use of selected, NIOSH-approved 3M™ Cartridges 6000 Series and Filters 2000 Series. For the listing of approved cartridges and filters, reference the NIOSH approval label included with 3M dual airline adapter kits.

To assemble 3M™ Dual Airline Combination Breathing Tubes with 3M™ Cartridges/Filters, the facepiece, inhalation valves must be removed.

If the facepiece is to be used in air-purifying mode (without using the 3M SA-1600 or SA-2600 breathing tubes), the inhalation valves must be replaced in the facepiece before use.

Using the 3M™ Combination Dual Airline Breathing Tubes without Cartridges and/or Filters

To use the 3M combination dual airline breathing tubes (SA-1600 and SA-2600) without cartridges or filters, attach a 3M™ Bayonet Cap 6880 to each outer bayonet mount on the dual airline breathing tube. When used as a straight, Type C, continuous flow supplied air respirator, the Assigned Protection Factor is 1000 times the PEL, OEL or TLV guidelines for full facepiece respirators.

WARNING

The 3M™ Dual Airline is NIOSH approved only with the nose cup 6894 in place. Failure to do so **may result in sickness or death.**

FITTING INSTRUCTIONS

Must be followed each time respirator is worn.

Note: Do not use with beards or other facial hair or other conditions that prevent a good seal between the face and the faceseal of the respirator. Standard eyeglasses cannot be worn with full facepiece respirators. If corrective eyeglasses are required a 3M Spectacle Kit must be used inside the respirator. To help maintain a good seal between the face and the faceseal all hair, hoods, or other equipment must be kept out of respirator faceseal area at all times.

Donning Respirator

1. Fully loosen all four head straps. With one hand pull hair back out of facepiece sealing area. Place chin in the respirator chin cup. While holding the facepiece in place, pull the head harness to back of head.(Fig. 6)
2. Pull the ends of the four straps to adjust tightness, starting with the neck straps first, then the forehead straps. Do not overtighten the straps. (Fig. 7)
3. Perform a positive and/or negative pressure user seal check each time the respirator is donned.



Fig. 6



Fig. 7

User Seal Checks

Always check the seal of the respirator on your face before entering a contaminated area.

Positive Pressure User Seal Check

1. Place the palm of your hand over the opening in the exhalation valve cover and exhale gently.
2. If the facepiece bulges slightly and no air leaks are detected between the face and the facepiece, a proper seal has been obtained. (Fig. 8)
3. If faceseal air leakage is detected, reposition the respirator on your face and/or readjust the tension of the straps to eliminate leakage and recheck seal.

If you cannot achieve a proper seal, DO NOT enter contaminated area. See your supervisor.

Negative Pressure User Seal Check with 6000 Series Cartridges

1. Place palms of hands to cover face of cartridge or open area of 3M™ Filter Retainer 501 and inhale gently. If you feel the facepiece collapse slightly and pull closer to your face with no leaks between the face and facepiece, a proper seal has been obtained. (Fig. 9)
2. If faceseal air leakage is detected, reposition the respirator on your face and/or readjust the tension of the straps to eliminate leakage and recheck seal.

If you cannot achieve a proper seal, DO NOT enter contaminated area. See your supervisor.

Note: Use of filter retainer 501 may aid respirator wearer in conducting a negative pressure user seal check.



Fig. 8



Fig. 9

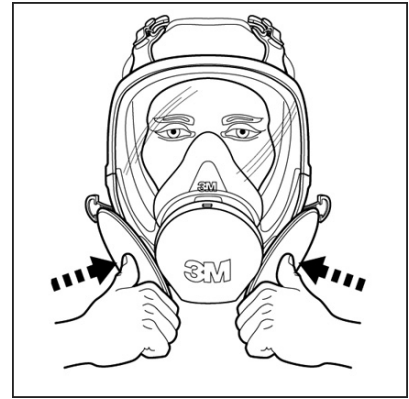

Fig. 10

Negative Pressure User Seal Check with Filters 2000 Series

1. Place your thumbs onto the center portion of the filters, restricting airflow through filters and inhale gently. If you feel the facepiece collapse slightly and pull closer to your face with no leaks between the face and facepiece, a proper seal has been obtained. (Fig. 10)
2. If faceseal air leakage is detected, reposition the respirator on your face and/or readjust the tension of the straps to eliminate the leakage and recheck seal.

If you cannot achieve a proper seal, DO NOT enter contaminated area. See your supervisor.

Negative Pressure User Seal Check with Filters 7093/7093C

1. Using hands press filter covers toward facepiece and inhale gently. If you feel the facepiece collapse slightly and pull closer to your face with no leaks between the face and facepiece a proper seal has been obtained.
2. If faceseal air leakage is detected, reposition the respirator on your face and/or readjust the tension of the straps to eliminate the leakage and recheck seal.

If you cannot achieve a proper seal, DO NOT enter contaminated area. See your supervisor.

Negative Pressure User Seal Check with Dual Airline

1. Disconnect airline hose from air control valve.
2. With breathing tube still connected to the air control valve inhale gently. If you feel facepiece collapse slightly and pull closer to your face with no leaks between the face and facepiece, a proper seal has been obtained.
3. For Combination Dual Airline where cartridges or filters are attached perform user seal check as described above under the appropriate cartridge or filter that is being used.
4. If faceseal air leakage is detected, reposition the respirator on your face and/or readjust the tension of the straps to eliminate the leakage and recheck seal.

If you cannot achieve a proper seal, DO NOT enter contaminated area. See your supervisor.

Note: Before assigning any respirator to be worn in a contaminated area, a qualitative or quantitative fit test must be performed per OSHA Standard 1910.134, or CSA Standard Z94.4.

RESPIRATOR REMOVAL

1. Fully loosen all four head straps by lifting up on buckles.
2. Remove respirator by pulling straps over head.

FIT TESTING

The effectiveness of a respirator will be reduced if it is not fitted properly. Therefore, either qualitative or quantitative fit testing must be conducted prior to the respirator being used.

Note: Fit testing is both a U.S. Occupational Safety and Health Administration (OSHA) and Canadian requirement.

Quantitative Fit Testing

Quantitative Fit Testing (QNFT) can be conducted using a 3M™ Fit Test Adapter 601 and 42 CFR 84 P100 filters such as the 3M™ Particulate Filters 2091 or 7093.

Qualitative Fit Testing

Qualitative Fit Testing (QLFT) with the 3M™ Qualitative Fit Test Apparatus FT-10 or FT-30 can be conducted using any of the NIOSH approved 42 CFR 84 Particulate filters.

Fit testing should be conducted using the heaviest cartridge, canister, filter or combination that each wearer will use in their work environment. Respirators should also be fit tested while wearing any personal protective equipment (PPE) the wearer may use in their work environment that may affect the fit of the respirator (e.g. hoods, hardhats, safety glasses, hearing protections, etc.).

Note: For further information concerning fit testing, contact 3M OH&ESD Technical Service at 1-800-243-4630 or a 3M location in your region. In Canada call Technical Service at 1-800-267-4414.

INSPECTION, CLEANING, AND STORAGE

Inspection Procedure

This respirator must be inspected before each use to ensure that it is in good operating condition. Any damaged or defective parts must be replaced before use. Do not enter a contaminated area with damaged or defective parts. The following inspection procedure is recommended.

1. Check facepiece for cracks, tears and dirt. Be certain facepiece, especially facesal area, is not distorted.
2. Examine inhalation valves for signs of distortion, cracking or tearing.
3. Make sure that head straps are intact and have good elasticity.
4. Examine all plastic parts for signs of cracking or fatiguing. Make sure filter gaskets are properly seated and in good condition.
5. Remove exhalation valve cover and examine exhalation valve and valve seat for signs of dirt, distortion, cracking or tearing. Replace exhalation valve cover.
6. Inspect lens for any damage that may impair respirator performance or vision.

Cleaning and Storage

Cleaning is recommended after each use.

WARNING

Do not clean respirator with solvents. Cleaning with solvents may degrade some respirator components and reduce respirator effectiveness. Inspect all respirator components before each use to ensure proper operating condition. **Failure to do so may result in sickness or death.**

1. Remove cartridges, filters and/or breathing tubes. The center adapter, lens and face seal can also be removed if necessary.
2. Clean facepiece (excluding filters and cartridges), by immersing in warm cleaning solution, water temperature not to exceed 120°F (49°C), and scrub with soft brush until clean. Add neutral detergent if necessary. Do not use cleaners containing lanolin or other oils.
3. Disinfect facepiece by soaking in a solution of quaternary ammonia disinfectant or sodium hypochloride (1oz. [30ML] household bleach in 2 gallons [7.5L] of water), or other disinfectant.
4. Rinse in fresh, warm water and air dry in noncontaminated atmosphere.
5. Respirator components must be inspected prior to each use. A respirator with any damaged or deteriorated components should be repaired or discarded.
6. The cleaned respirator should be stored away from contaminated areas when not in use.

REPLACEMENT PART INSTRUCTIONS

3M™ Facepiece Assemblies for 6700/6800/6900

The facepiece consists of the head harness assembly, nose cup assembly, center adapter assembly, lens assembly, faceseal (small, medium or large), and frame assembly (top, bottom, nuts and screws).

To disassemble lens assembly from faceseal, remove the two Phillips screws from top frame. Then, pull the frame top and frame bottom away from the faceseal. The frame top, frame bottom, faceseal and the lens assembly have vertical line markings that indicate their positions relative to one another. Make certain these markings are aligned for reassembly.

3M™ Center Adapter Assembly 6864 Replacement

The center adapter assembly consists of center adapter base, cover, exhalation valve, and adapter gasket. It is secured to the center port of the lens with a bayonet style twist lock connection, which compresses the sealing gasket.

To remove the center adapter from the facepiece:

1. Remove nose cup assembly by pulling away from center adapter inside facepiece. (Fig. 11)
2. Grasp center adapter at cover and twist counter-clockwise 1/4 turn to disengage bayonet from facepiece lens.
3. Withdraw center adapter from lens center port.

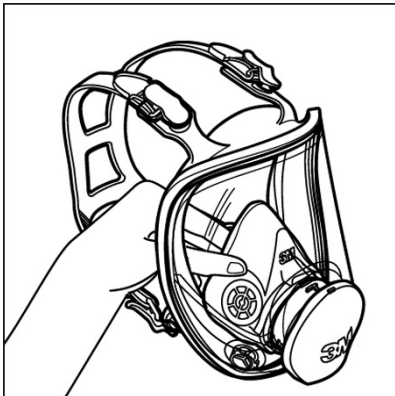

Fig. 11

To install the center adapter into the facepiece:

1. Align tabs on center adapter base with notches in center port of facepiece lens.
2. Slide adapter into lens port. (Fig. 12)
3. Grasp center adapter at cover and twist clockwise 1/4 turn to stop. Be certain center adapter gasket is properly in place and sealed, and that the adapter assembly is fully engaged.
4. Replace nose cup assembly.

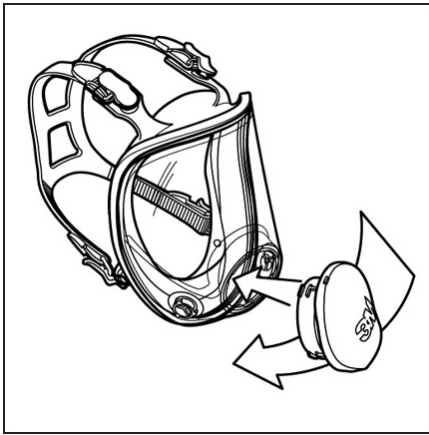

Fig. 12

Converting from the Standard Center Adapter 6864 to the DIN Port Adapter 6884

Any Full Facepiece 6000 Series can be converted to the desired center adapter assembly by following the instructions in 3M Center Adapter Assembly Replacement and installing the 6880 bayonet caps with 6895 Inhalation Port Gaskets or the Full Face plug 7800 with Breathing Tube Gasket 6876 as appropriate.

3M™ Nose Cup Assembly 6894 Replacement

The nose cup assembly replacement 6894 consists of a nose cup and inhalation valves. It is designed to install onto the center adapter and comfortably fit over the respirator wearer's mouth and nose to aid in purging exhaled breath and prevent lens fogging.

1. Remove the nose cup assembly by pulling away from center adapter inside facepiece. (Fig. 11)
2. To replace, position nose cup assembly onto center adapter aligning arrows. (Fig. 13)

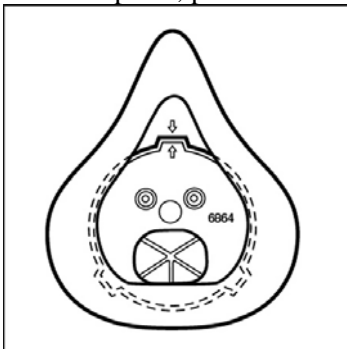

Fig. 13

3M™ Center Adapter Gasket 6896 Replacement

The center adapter gasket replacement is designed to seal the interface between the center adapter and the lens of the Full Facepiece 6000 Series.

1. Remove nose cup assembly by pulling away from center adapter inside facepiece. (Fig. 11)
2. Grasp center adapter at cover and twist counter-clockwise 1/4 turn to disengage from facepiece lens. Withdraw center adapter from lens center port.
3. Remove old gasket 6896 from center adapter and replace with new replacement gasket 6896.
4. Re-install center adapter into facepiece lens. (Fig. 12)
5. Replace nose cup assembly.

3M™ Inhalation Valve 6893 Replacement

Inhalation valves are located on posts at the inside of the facepiece inhalation ports and inside the nose cup

inhalation ports. These valves should be inspected before each respirator use and replaced whenever valves become damaged or lost.

1. Remove existing valve(s) by lifting from post(s).
2. Install new valve(s) onto post(s). Be certain valve(s) is fully engaged under all three lugs on post(s), lays flat, and moves freely (spins) on post.

3M™ Exhalation Valve 7583 Replacement

1. Remove center adapter cover by pulling out from bottom latch.
2. Grasp valve and pull each valve stem out from valve seat. (Fig. 14)
3. Inspect valve seat making certain it is clean and in good condition.
4. Place new exhalation valve replacement over the exhalation port by inserting stems and pulling through from the opposite side until they are both snapped in place. (Fig. 15 and 16)
5. Replace valve cover by aligning and inserting the top opening in the valve cover with the top tab on the center adapter base. Rotate the cover down until it snaps to the center adapter base. An audible click should be heard.

Note: Conduct a negative pressure user seal check to ensure exhalation valve is functioning properly.

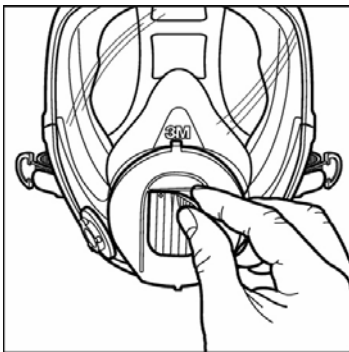

Fig. 14

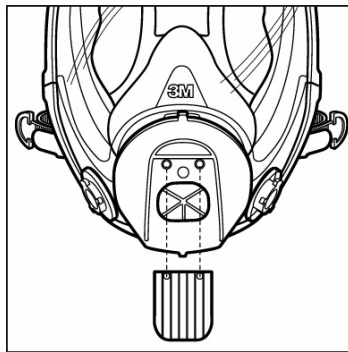

Fig. 15

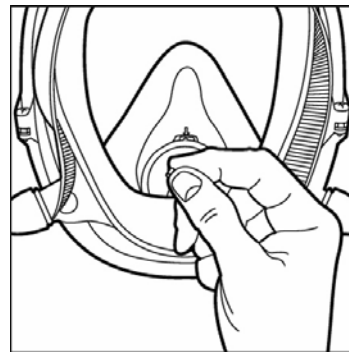

Fig. 16

3M™ Inhalation Port Gasket 6895 Replacement

The inhalation port gasket 6895 replacement is designed to seal the interface between the bayonet attachment inhalation ports on the facepiece and filters/cartridges, or dual airline breathing tubes installed on the facepieces. The gaskets should be inspected with each filter/cartridge change and replaced whenever damaged or seal integrity is questionable.

1. Remove gaskets from facepiece inhalation port bayonet fittings.
2. Install new gaskets onto facepiece inhalation port bayonet fittings. Be certain gaskets are in proper position under all three bayonet lugs. (Fig. 17)

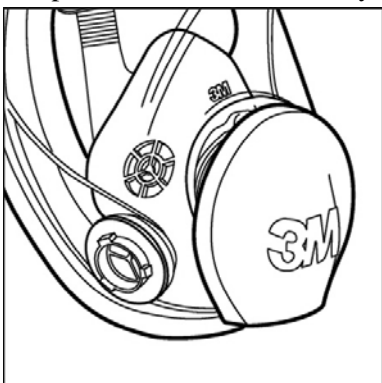

Fig. 17

3M™ Head Harness Replacement 6897

Read and follow Head Harness Assembly 6897 Replacement Instructions included with replacement Head Harness for instructions on removing and replacing the Head Harness.

3M™ Lens Assembly 6898

The lens assembly 6898 consists of a hard-coated polycarbonate lens with installed bayonet attachment inhalation port fittings, inhalation valves, and inhalation port filter/cartridge gaskets. The lens assembly 6898 is replaceable by following these steps:

1. Remove nose cup assembly from inside facepiece. (Fig. 11)
2. Remove center adapter assembly by turning counter-clockwise 1/4 turn and withdrawing from lens center port.
3. Remove the (2) Phillips screws from the lens/facepiece frame. Pull the frame top and frame bottom away from facepiece.
4. Remove facepiece from lens.
5. Place new lens and facepiece together aligning marks at top and bottom. Position top and bottom frame, again aligning marks top and bottom. Install and securely tighten screws. Make certain alignment marks are properly aligned top and bottom with all components. (Fig. 18)
6. Install center adapter assembly. (Fig. 12)
7. Replace nose cup assembly. (Fig. 11)

3M™ Frame Kit 6899

The frame kit 6899 includes a frame top, frame bottom, (2) Phillips head screws and (2) hex head nuts. The frame kit secures and seals the 3M full facepiece 6000 series facepiece to the 3M lens assembly 6898.

1. After assembling the facepiece onto the lens, matching top and bottom alignment marks, position top frame, over lens and facepiece, aligning center vertical marks, then press in place.
2. Position bottom frame, aligning center vertical mark, and press in place. (Fig. 18)

3. Insert and tighten Phillips head screws. Make certain parts are properly aligned and sealed together.

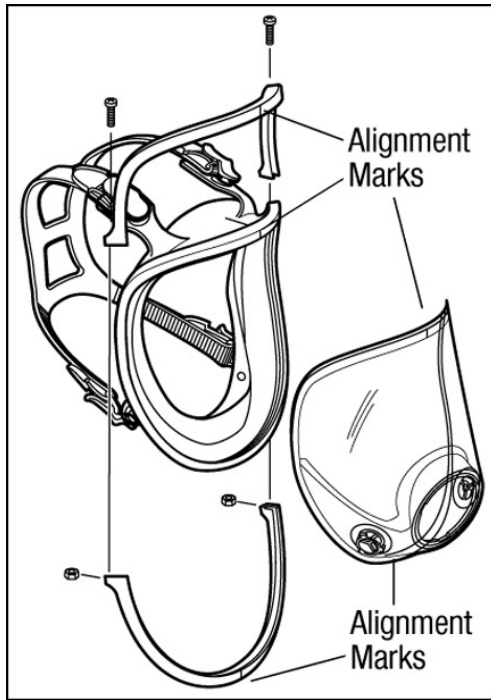

Fig. 18

FOR MORE INFORMATION

In United States, contact:

Website: www.3M.com/OccSafety

Technical Assistance: 1-800-243-4630

For other 3M products:

1-800-3M-HELPS or 1-651-737-6501

U.S. PATENTS

5,924,420

Des. 378,610

Des. 379,160

Des.388,872

Des. 490,744

**3M Occupational Health and
Environmental Safety Division**

3M Center, Building 235-02-W-70
St. Paul, MN 55144-1000

Tychem® is a registered trademark of DuPont

©3M 2007

98-0060-0035-4/3